

Owner's Guide

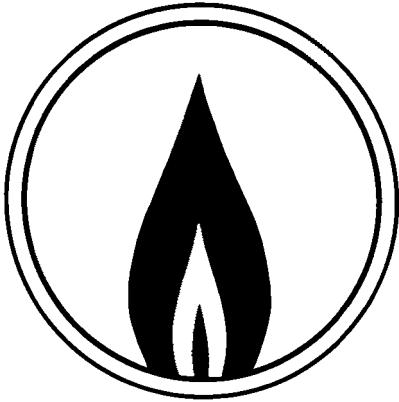

20-inch Manual Clean Gas Range

TABLE OF CONTENTS

IMPORTANT SAFETY INSTRUCTIONS	2-4	• Cooktop	11
ABOUT YOUR COOKTOP	5-6	• Grates	11
• Ignition system	5	• Surface burners	11
• Surface burners	5-6	• Oven door	12
• Cookware	6	• Oven bottom	12
ABOUT YOUR OVEN	7-8	• Broiler drawer	12
• Aluminum foil usage	7	• Oven rack	13
• Preheating	7	• Leveling legs	13
• Oven control	7	ABOUT SERVICE	14-15
• Cooking tips	8	• Troubleshooting chart	14-15
CLEANING CHART	9-10	• How to remove range for cleaning and servicing	15
ABOUT YOUR RANGE	11-13	• Electrical connection	15
• Ignition system	11	WARRANTY	16

INSTALLER Please leave this manual with this appliance.

CONSUMER Please read and keep this manual for future reference. Keep sales receipt and/or cancelled check as proof of purchase.

Model Number: _____

Serial Number: _____

Date of Purchase: _____

Model and serial numbers are on the rating plate, which is located on the sides of the lower range front frame. Use these numbers when requesting service.

**FOR CUSTOMER ASSISTANCE CALL 1-800-688-9900 USA
1-800-688-2002 Canada**

8113P705-60
A/01/08

Thank You . . . for purchasing our cooking appliance. To help you obtain the maximum in cooking satisfaction, we offer these suggestions:

- ☞ Read this manual before using the appliance.
- ☞ Review all safety and caution instructions.
- ☞ Review the Troubleshooting Chart on pages 14 and 15 if service becomes necessary.
- ☞ Include the model and serial numbers of your appliance when requesting service.
 - Proof of purchase such as sales receipt will be needed for warranty service.
- ☞ You can contact us at:

Maytag Appliances Sales Company
 Attn: CAIRSM Center
 P. O. Box 2370
 Cleveland, TN 37320-2370
1-800-688-9900 USA 1-800-688-2002 Canada

In our continuing effort to improve the quality and performance of our cooking appliances, it may be necessary to make changes to the appliance without revising this manual.

Read and follow all instructions before using this appliance to prevent the potential risk of fire, electric shock, personal injury or damage to the appliance as a result of improper usage of the appliance. Use appliance only for its intended purpose as described in this manual.

Read all instructions before using this appliance.

IMPORTANT INSTRUCTIONS

The following instructions are based on safety considerations and must be strictly followed to eliminate the potential risks of fire, electric shock, or personal injury.

Have your appliance installed and properly grounded by a qualified installer according to the installation instructions. Have the installer show you the location of the gas shut off valve and how to shut it off in an emergency.

Always disconnect power to appliance before servicing.

To ensure proper operation and avoid possible injury or damage to unit do not attempt to adjust, repair, service, or replace any part of your appliance unless it is specifically recommended in this book. All other servicing should be referred to a qualified installer or servicer.

WARNING: If the information in this manual is not followed exactly, a fire or explosion may result causing property damage, personal injury or death.

- Do not store or use gasoline or other flammable vapors and liquids in the vicinity of this or any other appliance.
- **WHAT TO DO IF YOU SMELL GAS:**
 - Do not try to light any appliance.
 - Do not touch any electrical switch; do not use any phone in your building.
 - Immediately call your gas supplier from a neighbor's phone. Follow the gas supplier's instructions.
 - If you cannot reach your gas supplier, call the fire department.
- Installation and service must be performed by a qualified installer, service agency or the gas supplier.



! WARNING

- ALL RANGES CAN TIP AND CAUSE INJURIES TO PERSONS.
- INSTALL ANTI-TIP DEVICES PACKED WITH RANGE.
- FOLLOW ALL INSTALLATION INSTRUCTIONS.

WARNING: To reduce the risk of tipping of the appliance from abnormal usage or by excessive loading of the oven door, the appliance must be secured by a properly installed anti-tip device. If the range is moved from the wall, be sure the anti-tip device is engaged when the range is replaced. Look underneath range to verify that one of the rear leveling legs is properly engaged in the bracket slot. The anti-tip device secures the rear leveling leg to the floor when properly engaged. Also, be sure the range is properly re-installed.

IMPORTANT SAFETY INSTRUCTIONS

3

CHILD SAFETY

Do not leave children alone or unsupervised near the appliance when it is in use or is still hot. Children should never be allowed to sit or stand on any part of the appliance.

Children must be taught that the appliance and utensils in it can be hot. Let hot utensils cool in a safe place, out of reach of small children. Children should be taught that an appliance is not a toy. Children should not be allowed to play with controls or other parts of the unit.

CAUTION: Do not store items of interest to children in cabinets above an appliance or on the backguard of a range. Children climbing on the appliance or on the appliance door to reach items could be seriously injured.

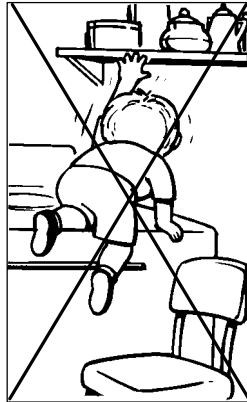

ABOUT YOUR APPLIANCE

WARNING

NEVER use appliance door as a step stool or seat as this may result in possible tipping of the appliance and serious injuries.

NEVER use this appliance as a space heater to heat or warm a room. Doing so may result in carbon monoxide poisoning and overheating of the oven.

NEVER cover any slots, holes or passages in the oven bottom or cover the entire rack with materials such as aluminum foil. Doing so blocks air flow through the oven and may cause carbon monoxide poisoning. Aluminum foil may also trap heat causing a fire hazard.

NEVER obstruct the flow of combustion and ventilation air by blocking the oven vent or air intakes. Doing so restricts air to the burners and may result in carbon monoxide poisoning.

Do not use the cooktop or oven as a storage area for food or cooking utensils.

Avoid touching oven vent area while oven is on and for several minutes after oven is turned off. Some parts of the vent and surrounding area become hot enough to cause burns. After oven is turned off, do not touch the oven vent or surrounding areas until they have had sufficient time to cool.

Do not touch a hot oven light bulb with a damp cloth as the bulb could break. Should the bulb break, disconnect power to the appliance before removing bulb to avoid electrical shock.

CHILD SAFETY

Always place a pan on a surface burner before turning it on. Be sure you know which knob controls which surface burner. Make sure the correct burner is turned on and that the burner has ignited. When cooking is completed, turn burner off before removing pan to prevent exposure to burner flame.

Always adjust surface burner flame so that it does not extend beyond the bottom edge of the pan. An excessive flame is hazardous, wastes energy and may damage the appliance, pan or cabinets above the appliance.

Never leave a surface cooking operation unattended especially when using a high heat setting or when deep fat frying. Boilovers cause smoking and greasy spillovers may ignite. Clean up greasy spills as soon as possible. Do not use high heat for extended cooking operations.

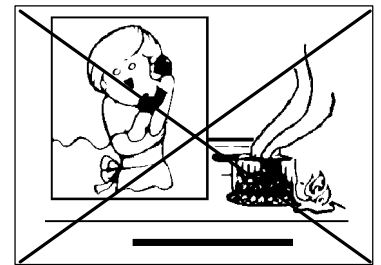

Never heat an unopened container on the surface burner or in the oven. Pressure build-up may cause container to burst resulting in serious personal injury or damage to the appliance.

Use dry, sturdy pot holders. Damp pot holders may cause burns from steam. Dish towels or other substitutes should never be used as pot holders because they can trail across hot surface burners and ignite or get caught on appliance parts.

Always let quantities of hot fat used for deep fat frying cool before attempting to move or handle.

Do not let cooking grease or other flammable materials accumulate in or near the appliance, hood or vent fan. Clean hood frequently to prevent grease from accumulating on hood or filter. When flaming foods under the hood, turn the fan on.

4

IMPORTANT SAFETY INSTRUCTIONS

Use caution when wearing garments made of flammable material to avoid clothing fires. Loose fitting or long hanging-sleeved apparel should not be worn while cooking. Clothing may ignite or catch utensil handles.

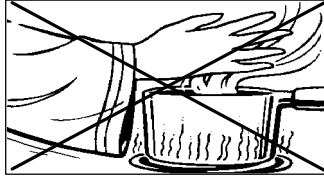

Always place oven racks in the desired positions while oven is cool. Slide oven rack out to add or remove food, using dry sturdy pot holders. Always avoid reaching into the oven to add or remove food. If a rack must be moved while hot, use a dry pot holder. Always turn the oven off at the end of cooking.

Use care when opening the oven door. Let hot air or steam escape before removing or replacing food.

PREPARED FOOD WARNING: Follow food manufacturer's instructions. If a plastic frozen food container and/or its cover distorts, warps, or is otherwise damaged during cooking, immediately discard the food and its container. The food could be contaminated.

UTENSIL SAFETY

Use pans with flat bottoms and handles that are easily grasped and stay cool. Avoid using unstable, warped, easily tipped or loose handled pans. Pans that are heavy to move when filled with food may also be hazardous.

To minimize burns, ignition of flammable materials and spillage due to unintentional contact with the utensil, do not extend handles over adjacent surface burners. Always turn pan handles toward the side or back of the appliance, not out into the room where they are easily hit or reached by small children.

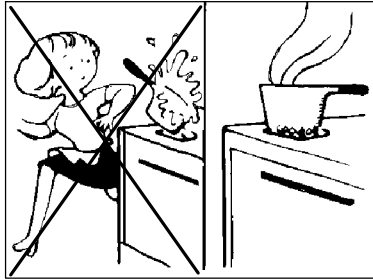

Never let a pan boil dry as this could damage the utensil and the appliance.

Follow the manufacturer's directions when using oven cooking bags.

Only certain types of glass, glass/ceramic, ceramic, or glazed utensils are suitable for cooktop or oven usage without breaking due to the sudden change in temperature.

This appliance has been tested for safe performance using conventional cookware. Do not use any devices or accessories that are not specifically recommended in this manual. Do not use eyelid covers for the surface units, stove top grills, or add-on oven convection systems. The use of devices or accessories that are not expressly recommended in this manual can create serious safety hazards, result in performance problems, and reduce the life of the components of the appliance.

CLEANING SAFETY

Turn off all controls and wait for appliance parts to cool before touching or cleaning them. Do not touch the burner grates or surrounding areas until they have had sufficient time to cool.

Clean appliance with caution. Use care to avoid steam burns if a wet sponge or cloth is used to wipe spills on a hot surface. Some cleaners can produce noxious fumes if applied to a hot surface.

IMPORTANT SAFETY NOTICE AND WARNING

The California Safe Drinking Water and Toxic Enforcement Act of 1986 (Proposition 65) requires the Governor of California to publish a list of substances known to the State of California to cause cancer or reproductive harm, and requires businesses to warn customers of potential exposures to such substances.

Users of this appliance are hereby warned that the burning of gas can result in low-level exposure to some of the listed substances, including benzene, formaldehyde and soot, due primarily to the incomplete combustion of natural gas or liquid petroleum (LP) fuels. Properly adjusted burners will minimize incomplete combustion. Exposure to these substances can also be minimized by properly venting the burners to the outdoors by opening the windows and/or door in the room where the appliance is located.

SAVE THESE INSTRUCTIONS

IGNITION SYSTEM

Your cooktop will feature either **pilot** ignition or **pilotless** ignition. If the gas supply to the range is turned off, be sure all controls are set in the OFF position before re-supplying gas to the appliance.

Pilot Ignition

When the range is first installed, the pilots may be difficult to light due to air in the gas line. To bleed off air from the line, hold a lighted match next to the burner and turn knob on. When the burner lights, turn the knob off and proceed as directed below.

To light pilot: Raise cooktop and hold a lighted match near the pilot ports. There are two pilot ports.

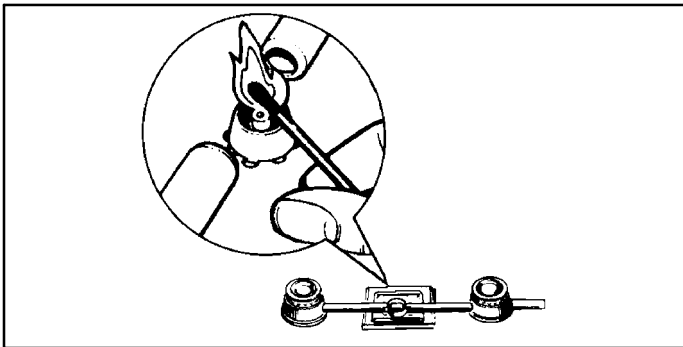

Pilotless Ignition

Pilotless ignition uses a spark from the ignitor to light the burner. There are two ignitors for conventional surface burners. Once the burner lights, turn the knob to the desired setting. The clicking sound will not stop until the knob is turned from the LITE position. Once the burner lights, turn the knob to the desired setting. The clicking sound will not stop until the knob is turned from the LITE position.

In the event of a power failure, the surface burner can be manually lighted. Be sure all controls are in the OFF position. Hold a lighted match to the desired surface burner head. Push in and turn knob to the LITE position. The burner will then light. Adjust the flame to the desired flame size.

HOW TO LIGHT SURFACE BURNERS

CAUTION: If the flame should go out during a cooking operation, turn the burner off. If gas has accumulated and a strong gas odor is detected, open a window and wait 5 minutes for the gas odor to disappear before relighting burner.

To prevent damage to the cooktop or pan, never operate surface burner without a pan in place, never allow a pan to boil dry and never operate a surface burner on HIGH for extended periods of time.

To light surface burner:

1. Place a pan on the burner grate.

NOTE: The burner flame may lift off the burner head and a “roaring” sound may be heard if a pan is not placed on the grate before lighting the burner.

2. Push in and turn knob to the LITE position.

Pilotless ignition models only: A clicking sound will be heard and the burner will light. When one burner is turned on, all ignitors will spark.

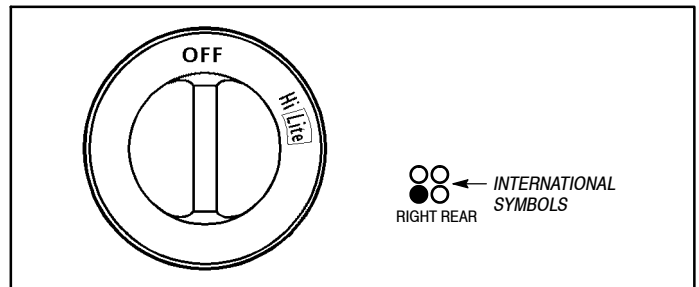

3. After the burner lights, turn the knob to the desired flame size.

Pilotless ignition models only: The ignitors will continue to spark until the knob is turned from the LITE position.

Adjust the flame size so it does not extend beyond the edge of the cooking utensil. This is for personal safety and to prevent possible damage to the appliance, pan, or cabinets above the appliance. This also improves cooking efficiency.

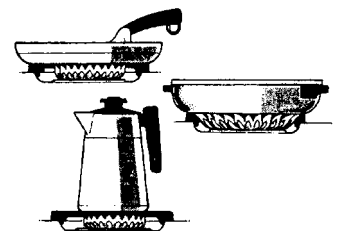

ABOUT YOUR COOKTOP

SELECTING FLAME SIZE

Use a HIGH flame setting to quickly bring liquids to a boil or to begin a cooking or canning operation. Then reduce to a lower setting to continue cooking. **Never leave food unattended when using a HIGH flame setting.**

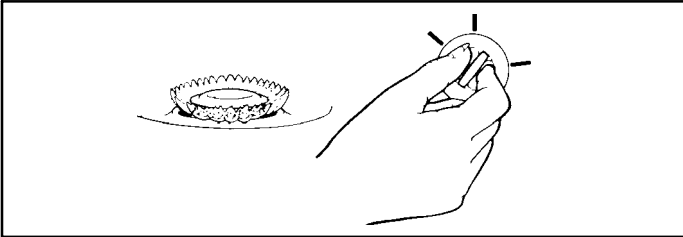

An intermediate flame size is used to continue a cooking operation. **Food will not cook any faster when a higher flame setting is used than needed to maintain a gentle boil.** Remember, water boils at the same temperature whether boiling gently or vigorously.

Use LO to simmer or keep foods at serving temperatures.

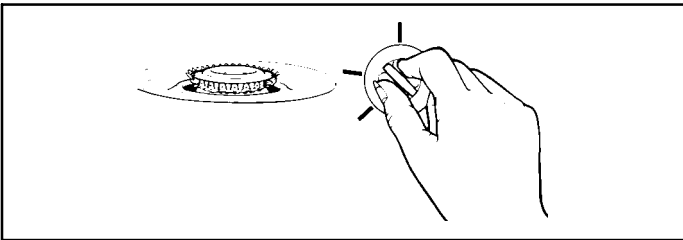

If a knob is turned very quickly from the HI to the LO setting, the flame may go out, particularly if the burner is cold. If this occurs, turn the knob to the OFF position. Wait several seconds, then light the burner again.

ABOUT THE SURFACE BURNER FLAME

A properly adjusted burner with clean ports will light within a few seconds. **You may hear a “popping” sound on some types of gas when the surface burner is turned off. This is a normal operating sound of the burner.**

On **natural gas**, the flame will be blue with a deeper blue core; there should be no trace of yellow in the flame. A yellow flame indicates an improper mixture of air/gas. Have a serviceman adjust the mixture if a yellow flame occurs. (**NOTE:** Adjustments are not covered by the warranty.)

On **LP gas**, some yellow tipping may occur. This is normal and adjustment is not necessary.

COOKWARE CONSIDERATIONS

Cookware, including canning equipment, which extends more than two inches beyond the grate, rests on two grates, or touches the cooktop will cause a build up of heat and may result in damage to the the burner grate, burner and cooktop.

Cookware, such as a wok with a support ring, which restricts air circulation around the burner will cause heat to build up and may result in damage to the burner grate, burner or cooktop.

Foods cook faster when the cookware is covered because more heat is retained. Lower the flame size when cookware is covered. This also improves cooking efficiency.

The cooking performance is greatly affected by the type of cookware used. Proper cookware will reduce cooking times, use less energy and produce more even cooking results. For best results use a heavy gauge metal pan with a smooth flat bottom, straight sides and a tight fitting lid. Select a material, such as aluminum or copper, that conducts heat quickly and evenly.

CANNING

When canning, use the HI setting just until the water comes to a boil or pressure is reached in a pressure canner, then reduce to a setting that maintains the pressure or a boil.

Prolonged use of the HI setting, the use of incorrect canning utensils, or the use of improper canning techniques may produce excessive heat and result in permanent damage to the appliance.

NOTE: For additional canning information contact your local County Extension Office. Or, contact Alltrista Consumer Products Company, marketer of Ball brand home canning products at 800-240-3340 or write: Alltrista Corp., Consumer Affairs Dept., P.O. Box 2729, Muncie, IN 47307-0729.

ABOUT YOUR OVEN

7

ALUMINUM FOIL USAGE

- Do not cover an entire oven rack or oven bottom with aluminum foil. This will reduce heat circulation, result in poor baking and may damage the oven bottom.
- Do not cover the broiler insert with aluminum foil. This prevents fat from draining into the pan below and increases flare-ups and smoke. However, the broiler pan may be lined with foil for easier clean-up.

PREHEATING

- Preheating is necessary for baking.
- It is not necessary to preheat for roasting.
- To preheat, set the oven to the desired temperature and allow about 8 to 15 minutes for the oven to preheat.
- When the oven reaches the preset temperature, the oven indicator light will turn off.
- Selecting a temperature higher than desired will NOT preheat the oven any faster, and may have a negative effect on baking results.

OVEN CONTROL

The OVEN TEMP knob is used to select the oven temperature.

Always turn this knob just TO the desired temperature.

To accurately set the oven temperature, do not turn to a higher temperature and then back.

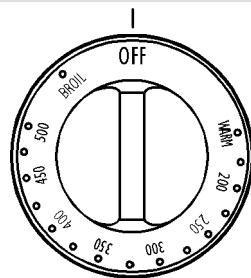

OVEN TEMP

HOW TO SET OVEN TO BAKE

1. When cool, position rack in oven.
2. Push in and turn OVEN TEMP knob to desired temperature.
3. Place food in center of oven, allowing a minimum of 2 inches between utensil and oven walls.
4. Check food for doneness at minimum time in recipe. Cook longer if necessary.
5. Remove food from the oven and turn the OVEN TEMP knob to OFF.

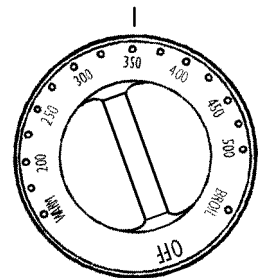

OVEN TEMP

HOW TO SET OVEN TO BROIL

1. Place broil rack and broiler pan in the recommended rack position.
2. Push in and turn OVEN TEMP knob to BROIL.
3. It is possible to broil longer cooking foods such as chicken pieces at a lower temperature to prevent overbrowning. Turn the knob to 400 or 450°F, rather than BROIL, for low temperature broiling.
4. Turn meat once about halfway through cooking.
5. Remove food from oven and turn the OVEN TEMP knob to OFF. After cleaning broiler pan, store it in the lower broil compartment.

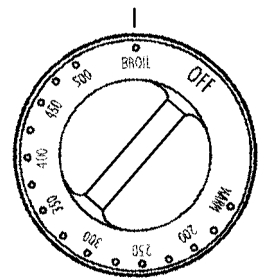

OVEN TEMP

BROILING CHART

TYPE OF MEAT	RACK POSITION	TOTAL TIME (MINUTES)
BACON	bottom	BROIL at 400°F 7 to 10 minutes (well)
BEEF STEAK 1-inch thick	middle	BROIL 15 to 20 minutes (med)
	middle	BROIL 20 to 25 minutes (well)
CHICKEN Pieces	bottom	BROIL at 450°F 30 to 45 minutes (well)
FISH	middle	BROIL 8 to 15 minutes (flaky)
HAMBURGERS 3/4-inch thick	middle	BROIL 14 to 18 minutes (well)

BAKING TIPS

Use a **reliable recipe** and accurately measure fresh ingredients. **Carefully follow directions** for oven temperature and cooking time. Preheat oven if recommended.

Use the correct rack position.

Baking results may be affected if the wrong rack position is used.

- Top browning may be darker if food is located toward the top of the oven.
- Bottom browning may be darker if food is located toward the bottom of the oven.

Bakeware material plays an important part in baking results. Always use the type and size of pan called for in the recipe. Cooking times or cooking results may be affected if the wrong size is used.

- **Shiny metal pan** reflects heat away from the food, produces lighter browning and a softer crust. Use shiny pans for baking cakes or cookies.
- **Dark metal pan or a pan with an anodized (dull) bottom** absorbs heat, produces darker browning and a crisper crust. Use this type of pan for pies, pie crusts or bread.
- If using **oven-proof glassware**, or **dark pans such as Baker's Secret** reduce the oven temperature by 25°F except when baking pies or bread. Use the same baking time as called for in the recipe.
- If using insulated bakeware, expect cooking times to increase slightly. It is not necessary to adjust the oven temperature.

If you add additional ingredients or alter the recipe, expect cooking times to increase or decrease slightly.

ROASTING TIPS

Roasting is the method for cooking large, tender cuts of meat uncovered, without adding moisture. Most meats are roasted at 325°F. It is not necessary to preheat the oven.

Place the meat fat-side-up on a rack in a shallow roasting pan. Placing the meat on a rack holds it out of the drippings, thus allowing better heat circulation for even cooking. As the fat on top of the roast melts, the meat is basted naturally, eliminating the need for additional basting.

The cooking time is determined by the weight of the meat and the desired doneness.

For more accurate results, use a meat thermometer. Insert it so the tip is in the center of the thickest part of the meat. It should not touch fat or bone.

Remove the roast from the oven when the thermometer registers the desired doneness.

NOTE: For more information about food safety, call USDA's Meat & Poultry Hotline at 1-800-535-4555.

For cooking information, write to the National Cattlemen's Beef Association, 444 North Michigan Avenue, Chicago, Illinois 60611, or call 1-800-368-3138.

BROILING TIPS

Broiling is used for tender cuts of meat or marinated meats, poultry, fish and some fruits and vegetables. The food is placed directly under the burner.

Cooking time is determined by the desired degree of doneness and the distance between the food and the burner.

For best results, steaks and chops should be at least 3/4-inch thick. Trim excess fat to prevent excessive spattering or smoking. Cut slashes in the outer edges of the fat to prevent curling during cooking.

Use a broiler pan with an insert designed to drain excess liquid and fat away from the cooking surface. This is to prevent spatters and smoke.

For a brown exterior and rare interior, meat should be close to the burner. For well-done meat, place the broiler pan farther from the burner.

Increasing the distance between the meat and the burner will help reduce spattering and smoking.

Foods that require turning should be turned only once during broiling. Turn after half the recommended cooking time.

CLEANING CHART

9

ABOUT CLEANING PRODUCTS

Read and carefully follow the manufacturer's instructions.

Test a small inconspicuous area using a very light pressure to see if the surface may scratch or discolor. This is particularly important for porcelain enamel, highly polished or shiny metal or plastic surfaces, and painted surfaces.

Glass Cleaners – Bon Ami, Cinch, Glass Plus, Windex.

Dishwashing Liquid Detergents – Dawn, Dove, Ivory, Joy.

Mild Liquid Spray Cleaners – Fantastik, Formula 409.

Non-Abrasive Cleaners – Bon Ami, paste of baking soda and water.

Mildly Abrasive Powder or Liquid All Purpose Cleaners – Ajax, Barkeepers Friend, Cameo, Comet, Soft Scrub.

Non-Abrasive or Scratchless Plastic or Nylon Scouring Pads or Sponges – Chore Boy Plastic Cleaning Puff, Scrunge Scrub Sponges, or Scotch-Brite No Scratch, Cookware or Kitchen Sponge.

Abrasive Scouring Pads – S.O.S., Brillo Steel Wool Soap, Scotch-Brite Pads.

(Brand names for the above cleaning products are registered trademarks of the respective manufacturers.)



CAUTION

- Be sure appliance is off and all parts are cool before handling or cleaning. This is to avoid damage and possible burns.
- If a part is removed, be sure it is correctly replaced.
- **To prevent staining or discoloration, clean appliance after each use.**

CLEANING CHART

PARTS	CLEANING AGENTS	CLEANING PROCEDURES
Broiler pan and insert	<ul style="list-style-type: none"> • Soap and water • Plastic or soap filled scouring pad • Dishwasher 	<p>Never cover insert with aluminum foil as this prevents the fat from draining to pan below.</p> <ol style="list-style-type: none"> 1. Remove from oven after use. Cool then pour off grease. 2. Place soapy cloth over insert and pan; let soak to loosen soil. 3. Wash in warm soapy water. Use soap filled scouring pad to remove stubborn soil. 4. Broiler pan and insert can be cleaned in the dishwasher.
Burner box	<ul style="list-style-type: none"> • Soap and water • Paste of baking soda and water • Non-abrasive plastic pad or sponge • Liquid cleaner • Glass cleaner 	<p>The burner box is located under the lift-up cooktop. Clean frequently to remove spillovers. If soil is not removed and is allowed to accumulate, it may damage the finish. To clean remove grates and surface burners and clean with soap and water, rinse and dry.</p>
Control knobs	<ul style="list-style-type: none"> • Soap and water • Mild liquid sprays • Glass cleaners 	<p>For ease of cleaning, turn off knob and remove by pulling forward.</p> <ol style="list-style-type: none"> 1. Wash, rinse, and dry. Do not use abrasive cleaning agents as they may scratch the finish and remove the markings. 2. Turn on each burner to be sure knobs have been correctly replaced.
Enamel, painted	<ul style="list-style-type: none"> • Soap and water • Mild liquid cleaner • Glass cleaner 	<p>NOTE: Use dry towel or cloth to wipe up spills, especially acid (milk, lemon juice, fruit, mustard, tomato sauce) or sugary spills. Surface may discolor or dull if soil is not immediately removed. This is especially important for white surfaces.</p> <ol style="list-style-type: none"> 1. When cool, wash with warm soapy water, rinse and dry. Never wipe a warm or hot surface with a damp cloth as this may damage the surface and may cause a steam burn. 2. For stubborn soil, use mildly abrasive cleaning agents such as baking soda paste or Bon Ami. 3. Do not use abrasive, caustic or harsh cleaning agents such as steel wool pads or oven cleaners. These products will scratch or permanently damage the surface.

CLEANING CHART

PARTS	CLEANING AGENTS	CLEANING PROCEDURES
Grates	<ul style="list-style-type: none"> • Soap and water • Non-abrasive plastic pad 	<p>Grates are made of porcelain-coated steel. They can be cleaned at the sink with soap and water or in the dishwasher. To clean baked on soil, place a damp soapy paper towel over the grate and let stand for 30 minutes. Use a non-abrasive plastic pad to scour stubborn soil.</p> <p>NOTE: Never operate burner without a grate in place. To protect the porcelain finish on the grate from excessive heat, never operate surface burner without a cooking utensil on the grate. It is normal for grates to lose their shine over a period of time.</p>
Metal finishes • Door handle	<ul style="list-style-type: none"> • Soap and water • Glass cleaner • Plastic or non-abrasive pad or sponge 	<ol style="list-style-type: none"> 1. Wash with soap and water or a glass cleaner and a soft cloth. 2. To prevent scratching or dulling of the finish, do not use mildly abrasive, abrasive, or harsh cleaners, or caustic cleaners such as oven cleaners.
Oven rack	<ul style="list-style-type: none"> • Soap and water • Plastic scouring pad • Cleansing powders • Soap-filled scouring pad 	<ol style="list-style-type: none"> 1. Clean with soapy water. 2. Remove stubborn soil with cleansing powder or soap-filled scouring pad. Rinse and dry.
Porcelain enamel • Cooktop • Oven bottom • Oven interior	<ul style="list-style-type: none"> • Soap and water • Paste of baking soda and water • Non-abrasive plastic pad or sponge • Oven cleaner 	<p>Porcelain enamel is glass fused on metal and may crack or chip with misuse. It is acid resistant, not acid proof. All spillovers, especially acid or sugar spillovers, should be wiped up immediately with a dry cloth. This is especially important around the vent opening for smoothtop cooktop. Surface may discolor or dull if soil is not removed.</p> <ol style="list-style-type: none"> 1. When cool, wash with soapy water, rinse and dry. 2. Never wipe off a warm or hot surface with a damp cloth. This may cause cracking and chipping. 3. Never use oven cleaners, abrasive or caustic cleaning agents on exterior finish of range. Oven cleaners can only be used on porcelain oven cavity. <p>NOTE: Protect oven bottom against excessive spillovers especially acid or sugary spillovers as they may discolor the porcelain. Use the correct size cooking utensil to avoid boilovers. Never place cookware or aluminum foil directly on the oven bottom.</p>
Silicone Rubber Door Gasket	<ul style="list-style-type: none"> • Soap and water 	<p>Door gasket is located on the oven front frame. DO NOT REMOVE GASKET. Wash with soap. Rinse thoroughly.</p>
Surface burners	<ul style="list-style-type: none"> • Soap and water • Paste of baking soda and water • Plastic scouring sponge or pad • Mildly abrasive cleaner 	<p>For ease of cleaning, remove soil from the burner as soon as burner has cooled. If food boils over, remove pan to another burner. Then, cool soiled burner and clean.</p> <p>Clean, when cool, after each use with warm soapy water. Remove stubborn soil by scouring with a non-abrasive plastic scouring pad and a paste of baking soda and water. Clean ports with a straight pin or small metal paper clip. Do not enlarge or distort the ports. Do not use a wooden toothpick. It may break off and clog port. Surface burners can be dried in the oven set at 170°F. Burner must be dry before use.</p>

IGNITION SYSTEM

Your oven will feature either **pilot ignition** or **pilotless ignition**. If the gas supply to the range is turned off, be sure all controls are set in the OFF position before re-supplying gas to the appliance.

Pilot Ignition

To light oven pilot: When cool, remove oven racks and oven bottom. With the oven thermostat knob in the OFF position, hold a lighted match to the pilot located at the back end of the oven burner. Once the pilot lights, replace oven bottom and racks.

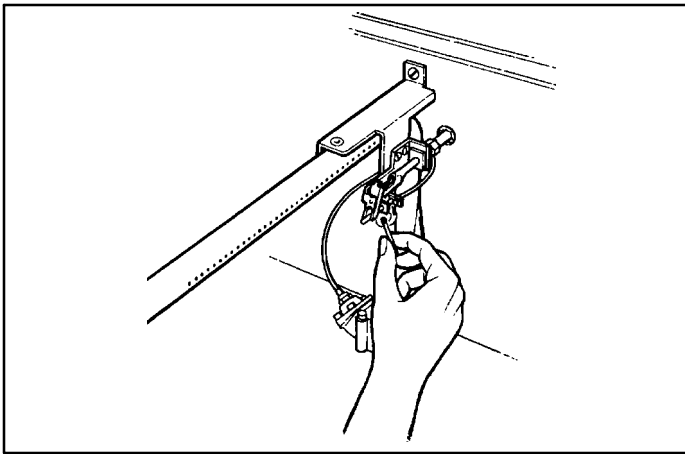

Pilotless Ignition

With this type of ignition system, a glo bar will light the oven burner. The oven will not operate during a power failure or if the oven is disconnected from the wall outlet.

NOTE: A lighted match will not light the burner. No attempt should be made to operate oven during a power failure.

COOKTOP

The cooktop featuring conventional surface burners lifts up for easy cleaning of the burner box area.

To remove: When cool, first remove grates and drip bowls, if equipped. Grasp two front burner wells and lift up. The top can be completely removed.

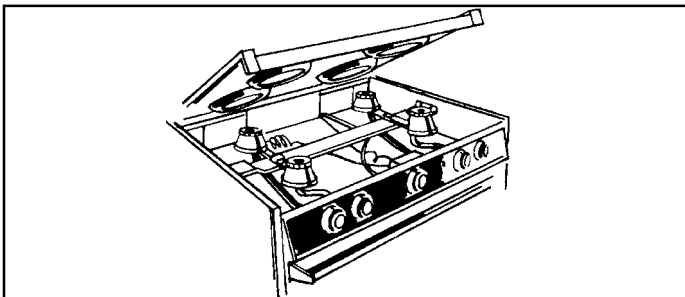

To replace: Insert the two pins on the back of the cooktop into the holes in the backguard. Lower the top into place applying pressure at the front edges to secure top to the range.

BURNER GRATES

CAUTION: Do not operate a surface burner without a pan on the grate. The porcelain finish on the grate may chip without a pan to absorb the intense heat from the burner flame.

Burner grates must be properly positioned before cooking. Burner grates are durable but may gradually lose their shine due to usage and high temperatures.

Grates for the porcelain cooktop are square. When installing square grates, place indented sides together so straight sides are at front and rear.

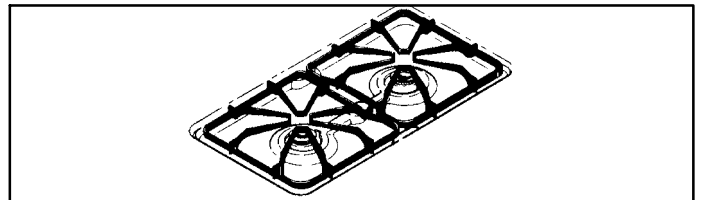

SURFACE BURNERS

Surface burners are secured in place during transportation with a shipping screw.

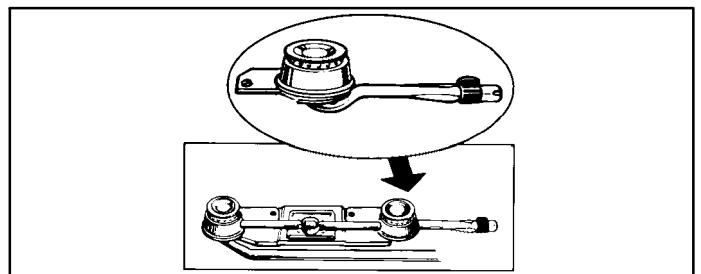

Once the range is installed, these may be removed to allow quick and easy removal of the burner.

To remove: Lift up and support or remove the cooktop. When cool, grasp burner head and tilt to release tab from slot near ignitor or pilot. Lift up and toward back of cooktop until air shutter end of burner releases from valve.

To replace: Insert air shutter end of burner over valve and lower into place. Replace cooktop. Turn on burner to be sure burner has been correctly replaced.

**CAUTION**

- Be sure all packing material is removed from oven before turning on.
- Do not use oven for storing food or cookware.
- Many aerosol-type spray cans are **EXPLOSIVE** when exposed to heat and may be highly flammable. Avoid their use or storage near the oven.
- Allow steam and hot air to escape before reaching into oven to check, add, or remove food.
- Prepared Food Warning: Follow food manufacturer's instructions. If a plastic frozen food container and/or its cover distorts, warps, or is otherwise damaged during cooking, immediately discard the food and its container. The food could be contaminated.
- Follow the manufacturer's directions when using oven cooking bags.

OVEN DOOR**CAUTION**

- **WARNING: NEVER** place excessive weight on or stand on an open oven door. This could cause the range to tip over, break the door, or injure the user.
- **NEVER** place fingers between hinge and front oven frame. Hinge arms are spring mounted. If accidentally hit, the hinge will slam shut against oven frame and could injure your fingers.

When baking, be sure oven door is completely closed. Baking results will be affected if door is not closed.

The oven door is not designed to be removed by the consumer.

When opening the oven door, allow steam and hot air to escape before reaching in oven to check, add or remove food.

OVEN BOTTOM

To remove: When cool, loosen the two screws located along the front of the oven bottom. Slide the screws back to release the front of the oven bottom. Grasp oven bottom, lift up and pull forward until rear tabs release. Then, remove oven bottom from oven.

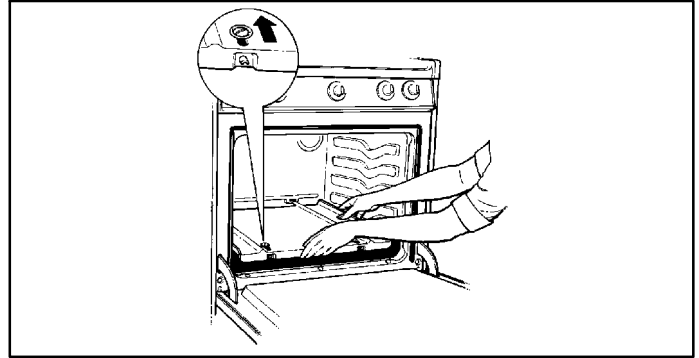

To replace: Insert the tabs into the slots on the back oven wall. Lower into place. Slide two screws forward and tighten. Be sure bottom is fitted into slots and screws are tight. If not correctly replaced, oven bottom may become warped and cooking results will be affected.

BROILER DRAWER

To remove: When broiler is cool, remove broiler insert and pan. Open drawer halfway and pull metal clip located in center of drawer bottom upward as far as it will go (about 2 inches). The drawer can now be pulled all the way out of the compartment.

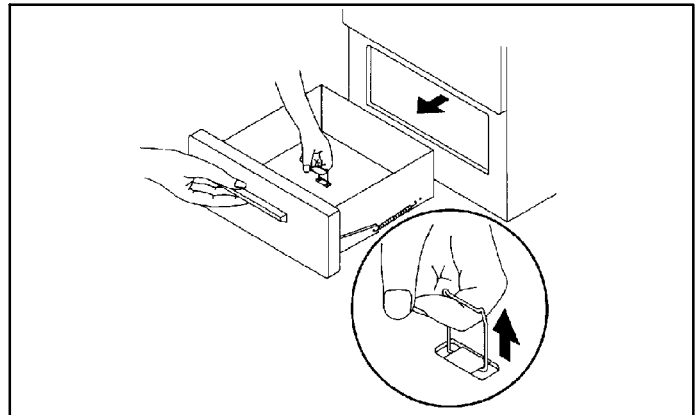

To replace: Slide grooves at top of drawer onto guide rails at sides of broiler compartment and push drawer in to close.

OVEN RACK



CAUTION

Do not attempt to change the rack position when the oven is hot.

The oven rack is designed with a safety lock-stop position. This prevents the rack from accidentally coming completely out of the oven when pulling the rack out to add or remove food.

To remove oven rack:

1. When rack is cool, pull rack straight out until it stops at the lock-stop position.

NOTE: If it is necessary to change rack position when rack is hot, use potholders to protect hands.

2. Tilt the front end of the rack up.
3. Continue pulling rack out of oven.

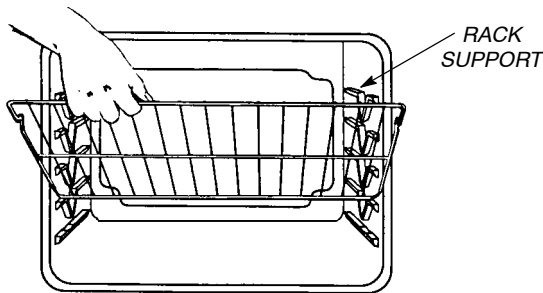

To replace oven rack:

1. Place rack on the rack supports in oven.
2. Tilt the front end of the rack up slightly.
3. Slide rack back until it clears the lock-stop position.
4. Lower front of rack and slide rack straight back into oven.
5. Pull rack out to the lock-stop position to be sure rack is correctly replaced. Push rack back into oven and close oven door.

Rack Positions:

- For optimum results, air must circulate freely within the oven and around the food. To help ensure this, place food in the center of the oven. Allow two inches between the edge of the pan(s) and the oven walls.
- Position the rack so the food is in the center of the oven. Use either rack position 2 or 3.

RACK 3: Used for baked goods on a cookie sheet or jelly roll pan, or frozen convenience foods.

RACK 2: Used for most baking, roasting small cuts of meat, and large casseroles.

RACK 1: Used for roasting large cuts of meat and large poultry, pies, souffles, or angel food cake.

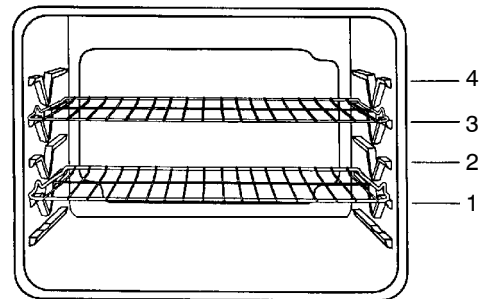

LEVELING LEGS



CAUTION

WARNING: The anti-tip bracket provided with this range must secure one of the rear leveling legs to the floor. This bracket prevents the range from accidentally tipping.

The installer should level the range when it is installed.

If the range is not level, turn the leveling legs, located at each corner of the range, until range is level. Place level on an oven rack to determine if range is level.

Cooking results can be affected if the range was not properly leveled during installation.

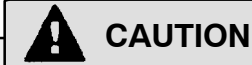

CAUTION

- Do not attempt to service this appliance yourself unless directed to do so in this manual or the chart below. Refer all other servicing to a qualified servicer or call us at **1-800-688-9900**.
- Locate and mark circuit breaker or fuse. Never replace a blown fuse or reset a circuit breaker until you know what caused the problem. Always replace a blown fuse with one of the correct amperage, do not use a substitute.
- Always disconnect power to unit **before** any servicing by tripping circuit breaker to the OFF position or by removing the fuse.

TROUBLESHOOTING CHART

PROBLEM	CAUSE	CORRECTION
Surface burner fails to light.	<ul style="list-style-type: none"> a. power supply not connected b. air in the gas line c. clogged burner port(s) d. surface control not completely turned to the LITE position or turned too quickly from the LITE position e. power failure (pilotless ignition) 	<ul style="list-style-type: none"> a. connect power, check circuit breaker or fuse box b. see page 5 for instructions on bleeding air from the gas line c. clean ports with straight pin or small metal paper clip d. turn control to the LITE position until the burner ignites, then turn control to desired flame size e. see page 5 to light burner during a power failure
Burner flame is uneven.	<ul style="list-style-type: none"> a. clogged burner port(s) 	<ul style="list-style-type: none"> a. clean ports with straight pin
Surface burner flame lifts off port or is yellow in color.	<ul style="list-style-type: none"> a. air/gas mixture not proper <p>NOTE: Some yellow tipping with LP gas is normal and acceptable.</p>	<ul style="list-style-type: none"> a. call serviceman to adjust burner <p>NOTE: Be sure installer properly adjusted range at time of installation.</p>
Oven burner fails to light.	<ul style="list-style-type: none"> a. power supply not connected b. power failure c. oven incorrectly set 	<ul style="list-style-type: none"> a. connect power, check circuit breaker or fuse box b. oven will not operate during a power failure c. See page 7
Popping sound heard when burner extinguishes.	This is a normal sound that occurs with some types of gas when a hot burner is turned off. The popping sound is not a safety hazard and will not damage the appliance.	
Baking results are not satisfactory. <ul style="list-style-type: none"> • browning is too pale, too dark or is uneven. • food cooks unevenly. • food is underdone or overdone. 	<ul style="list-style-type: none"> a. oven not preheated or set at correct temperature. b. used incorrect rack position c. incorrect use of aluminum foil d. oven bottom incorrectly replaced e. oven thermostat sensing device is out of the holding clip(s). 	<ul style="list-style-type: none"> a. preheat oven 8 to 15 minutes b. see page 13 c. see page 7 d. replace oven bottom correctly e. reinstall thermostat sensing device

PROBLEM	CAUSE	CORRECTION
Baking results differ from previous oven.	a. Oven seems hotter or cooler than your previous oven.	a. Oven temperatures may vary between the new and the old oven. As ovens age, the oven temperature often "drifts" and may become hotter or cooler. Also, newer ovens may operate differently from older ovens. You should expect some differences in baking results.
Oven smokes excessively during a broil operation.	a. food too close to burner b. meat has too much fat c. sauce applied too early or marinade not completely drained d. soiled broiler pan e. broiler insert covered with aluminum foil f. oven bottom is soiled	a. move broiler pan down one rack position b. trim fat c. apply sauce during last few minutes of cooking. If meat has been marinated, drain thoroughly before cooking d. always clean broiler pan and insert after each use e. never cover insert with foil as this prevents fat from draining to pan below f. clean oven bottom
Strong odor or light smoke when oven is turned on the first few times.	This is normal for a new range and will disappear after a few uses. Opening a window or turning on a fan will help remove the smoke and odor.	

HOW TO REMOVE RANGE FOR CLEANING AND SERVICING

Follow these procedures to remove appliance for cleaning or servicing:

1. Shut-off gas supply to appliance.
2. Disconnect electrical supply to appliance, if equipped.
3. Disconnect gas supply tubing to appliance.
4. Slide range forward to disengage range from the anti-tip bracket. (See Installation Instructions for location of bracket.)
5. Reverse procedure to reinstall. If gas line has been disconnected, check for gas leaks after reconnection. A qualified servicer should disconnect and reconnect the gas supply. (See Installation Instructions for gas leak test method.)

To prevent range from accidentally tipping, range must be secured to the floor by sliding rear leveling leg into an anti-tip bracket supplied with the range.

WARNING: Possible risks may result from abnormal usage, including excessive loading of the oven door and of the risk of tip over, should the appliance not be reinstalled according to the installation instructions.

ELECTRICAL CONNECTION

Appliances which require electrical power are equipped with a three-prong grounding plug which must be plugged directly into a properly grounded three-hole 120 volt electrical outlet.

Always disconnect power to appliance before servicing.

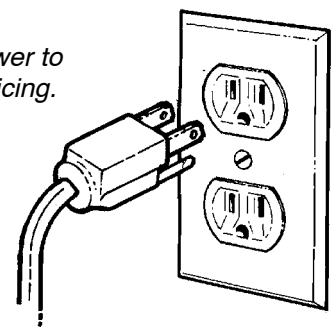

The three-prong grounding plug offers protection against shock hazards. **DO NOT CUT OR REMOVE THE THIRD GROUNDING PRONG FROM THE POWER CORD PLUG.**

If an ungrounded, two-hole or other type electrical outlet is encountered, **it is the personal responsibility of the appliance owner to have the outlet replaced with a properly grounded three-hole electrical outlet.**

MAYTAG® MAJOR APPLIANCE WARRANTY

LIMITED WARRANTY

For one year from the date of purchase, when this major appliance is operated and maintained according to instructions attached to or furnished with the product, Maytag brand of Whirlpool Corporation or Whirlpool Canada LP (hereafter "Maytag") will pay for factory specified parts and repair labor to correct defects in materials or workmanship. Service must be provided by a Maytag designated service company. This limited warranty is valid only in the United States or Canada and applies only when the major appliance is used in the country in which it was purchased. Outside the 50 United States and Canada, this limited warranty does not apply. Proof of original purchase date is required to obtain service under this limited warranty.

ITEMS EXCLUDED FROM WARRANTY

This limited warranty does not cover:

1. Service calls to correct the installation of your major appliance, to instruct you on how to use your major appliance, to replace or repair house fuses, or to correct house wiring or plumbing.
2. Service calls to repair or replace appliance light bulbs, air filters or water filters. Consumable parts are excluded from warranty coverage.
3. Repairs when your major appliance is used for other than normal, single-family household use or when it is used in a manner that is contrary to published user or operator instructions and/or installation instructions.
4. Damage resulting from accident, alteration, misuse, abuse, fire, flood, acts of God, improper installation, installation not in accordance with electrical or plumbing codes, or use of consumables or cleaning products not approved by Maytag.
5. Cosmetic damage, including scratches, dents, chips or other damage to the finish of your major appliance, unless such damage results from defects in materials or workmanship and is reported to Maytag within 30 days from the date of purchase.
6. Any food loss due to refrigerator or freezer product failures.
7. Costs associated with the removal from your home of your major appliance for repairs. This major appliance is designed to be repaired in the home and only in-home service is covered by this warranty.
8. Repairs to parts or systems resulting from unauthorized modifications made to the appliance.
9. Expenses for travel and transportation for product service if your major appliance is located in a remote area where service by an authorized Maytag servicer is not available.
10. The removal and reinstallation of your major appliance if it is installed in an inaccessible location or is not installed in accordance with published installation instructions.
11. Major appliances with original model/serial numbers that have been removed, altered or cannot be easily determined. This warranty is void if the factory applied serial number has been altered or removed from your major appliance.

The cost of repair or replacement under these excluded circumstances shall be borne by the customer.

DISCLAIMER OF IMPLIED WARRANTIES; LIMITATION OF REMEDIES

CUSTOMER'S SOLE AND EXCLUSIVE REMEDY UNDER THIS LIMITED WARRANTY SHALL BE PRODUCT REPAIR AS PROVIDED HEREIN. IMPLIED WARRANTIES, INCLUDING WARRANTIES OF MERCHANTABILITY OR FITNESS FOR A PARTICULAR PURPOSE, ARE LIMITED TO ONE YEAR OR THE SHORTEST PERIOD ALLOWED BY LAW. MAYTAG SHALL NOT BE LIABLE FOR INCIDENTAL OR CONSEQUENTIAL DAMAGES. SOME STATES AND PROVINCES DO NOT ALLOW THE EXCLUSION OR LIMITATION OF INCIDENTAL OR CONSEQUENTIAL DAMAGES, OR LIMITATIONS ON THE DURATION OF IMPLIED WARRANTIES OF MERCHANTABILITY OR FITNESS, SO THESE EXCLUSIONS OR LIMITATIONS MAY NOT APPLY TO YOU. THIS WARRANTY GIVES YOU SPECIFIC LEGAL RIGHTS, AND YOU MAY ALSO HAVE OTHER RIGHTS WHICH VARY FROM STATE TO STATE OR PROVINCE TO PROVINCE.

If outside the 50 United States and Canada, contact your authorized Maytag dealer to determine if another warranty applies.

If you need service, first see the "Troubleshooting" section of the Use & Care Guide. After checking "Troubleshooting," you may find additional help by checking the "Assistance or Service" section or by calling Maytag. In the U.S.A., call **1-800-688-9900**. In Canada, call **1-800-807-6777**.

9/07